

# ClimbTech

## LEGACY BOLT

5000-lbf / 22kN Model: CT-LGC50X4

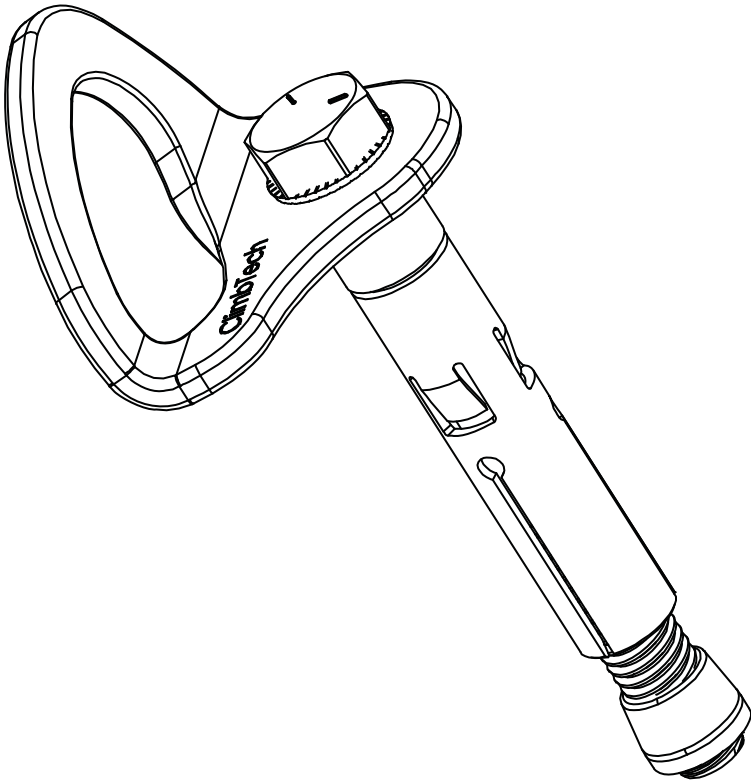

V1.3



### IMPORTANT!!!

ALL PERSONS USING THIS EQUIPMENT MUST READ AND UNDERSTAND ALL INSTRUCTIONS. FAILURE TO DO SO MAY RESULT IN SERIOUS INJURY OR DEATH. USERS SHOULD BE FAMILIAR WITH PERTINENT REGULATIONS GOVERNING THIS EQUIPMENT. ALL INDIVIDUALS WHO USE THIS PRODUCT MUST BE PROPERLY INSTRUCTED ON HOW TO USE THIS DEVICE.

## ***Read This Instruction Manual Carefully Before Using This Equipment.***

User Instructions must always be available to the user and are not to be removed except by the user of this equipment.

### **WARNING**

#### **WARNING**

For rock climbing and mountaineering use only. Understand and accept the risks involved before participating. It is the user's responsibility to read and understand the instructions, operation, limitations and consequences of improper use of this equipment **Misuse or failure to follow warnings and instructions may result in serious personal injury or death.**

#### **PURPOSE**

The Legacy Bolt is an anchorage connector designed for use in rock climbing and mountaineering only. Any references to "anchorage connector" in this manual include, and apply to, the Legacy Bolt.

#### **USE REQUIREMENTS**

1. The anchorage (substrate) must have the strength capable of supporting a static load, applied in the directions permitted by the system, of at least 5,000-lbf (22kN).
2. Use of this product must be compatible with any and all structural & operational characteristics of the selected installation location and system to be connected to this anchor. **Improper use may result in serious personal injury or death.**
3. The anchorage connector must be inspected prior to each use for wear, damage, and other deterioration. If defective components are found the anchorage connector must be immediately removed from service.
4. A rescue plan, and the means at hand to implement it, must be in place that provides the prompt rescue of users in the event of a fall, or assures that users are able to rescue themselves.

#### **USE LIMITATIONS**

1. The anchorage connector is designed for a single user, with a capacity up to 310 lbs (140kg) per user including clothing, tools, etc.
2. The anchorage connector is designed to be used in temperatures ranging from -40°F to +130°F (-40°C to +54°C).
3. Do not expose the anchorage connector to chemicals or harsh solutions which may have a harmful effect.
4. Do not alter or modify this product in anyway.
5. Additional requirements and limitations may apply depending on anchorage type. All placements must be approved by a qualified person. **Improper use may result in serious personal injury or death.**

#### **MAINTENANCE, CLEANING AND STORAGE**

Cleaning periodically will prolong the life and proper functioning of the product. The frequency of cleaning should be determined by inspection and by severity of the environment. Clean with compressed air and/or a stiff brush using plain water or a mild soap and water solution. Do not use any corrosive chemicals that could damage the product. Wipe all surfaces with a clean dry cloth and hang to dry, or use compressed air. When not in use, store anchorage connectors in a cool, dry, clean environment, free of corrosive or other degrading elements.

### **WARNING**

**WARNING: Laboratory test, inspections, and instructions for use do not cover the infinite possibilities and variables of field use. Using this product under real life conditions must always be done under the supervision of a trained, qualified person.**

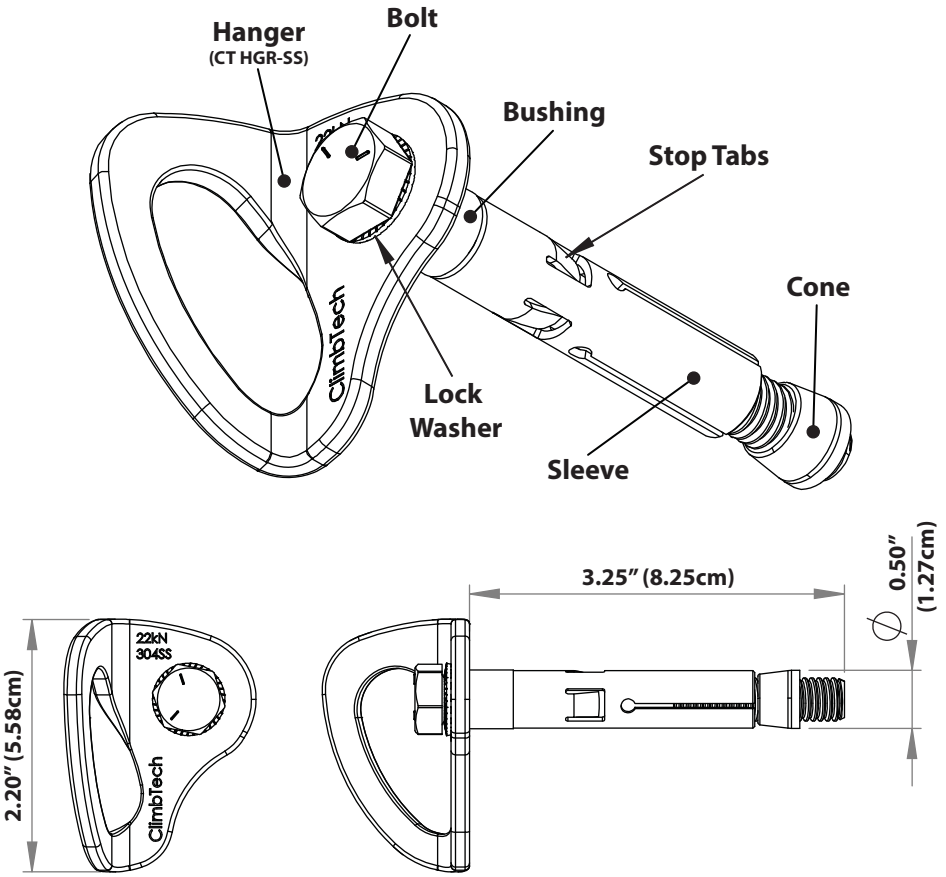

**TOOLS REQUIRED FOR INSTALLATION**

1/2" x 6" Minimum Bit Length  
 4" Usable Length

Torque Wrench  
 5/8"

5/8"

Detailed description: This section lists the tools required for installation. It includes a power drill with a 1/2" x 6" minimum bit length and a 4" usable length. A torque wrench with a 5/8" handle is also shown. A 5/8" wrench is also listed.

## DRILLING INSTRUCTIONS:

1. Hole location should be chosen by a "competent person". Drill a 1/2" [12.7mm] diameter hole at least 4" [102mm] deep. (1/2" x 6" SDS bit recommended)

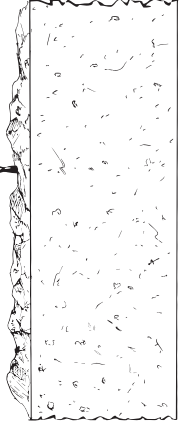

\*Placement of the Legacy Bolt should allow hanger to sit flush to the rock face. Avoid rock features that may interfere with ropes or carabiners.

2. Thoroughly remove loose debris from hole. (Use a hand pump or other means to blow out the hole.)

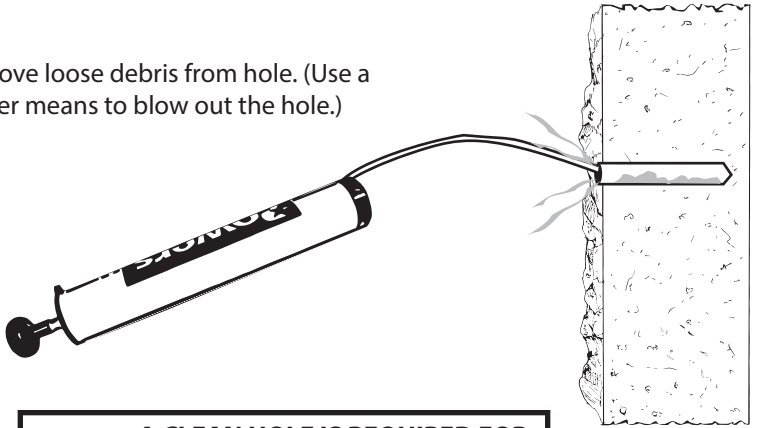

**A CLEAN HOLE IS REQUIRED FOR PROPER ENGAGEMENT OF THE LEGACY BOLT**

3. Use a 1/2" brush to further clean and dislodge any loose matter. Remove remaining debris (with hand pump, etc). Repeat until hole is clean.

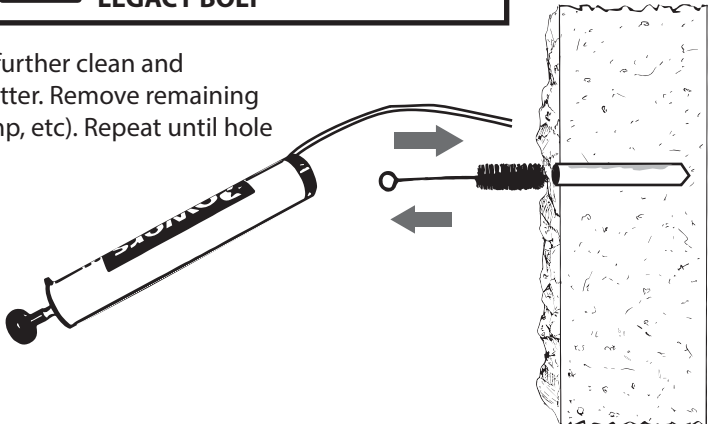

## INSTALLATION INSTRUCTIONS:

1. Make sure the cone is just touching the sleeve as shown in diagram below.

### PRESETTING THE LEGACY BOLT CONE

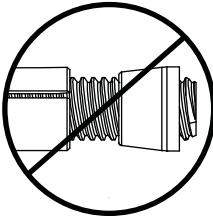

TOO LOOSE

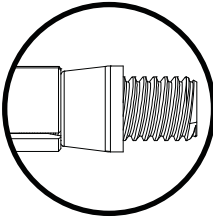

JUST TOUCHING

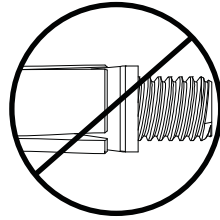

TOO TIGHT

\*NOTE: A viscous protectant (Lanolin wax, etc.) is recommended for protecting the bolt threads from mineral deposits that may impede the function of the removable bolt over time.

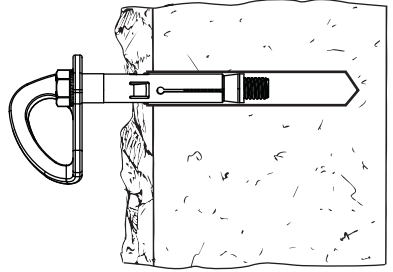

2. Insert Legacy Bolt into hole. While holding hanger flush with rock face, pull out on the bolt and tighten (turning clockwise) with your fingers until bolt is screwed completely down. With hanger in desired orientation, torque bolt to 20 ft-lbf. (27Nm).

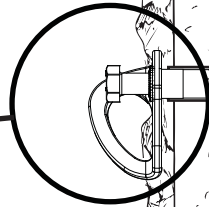
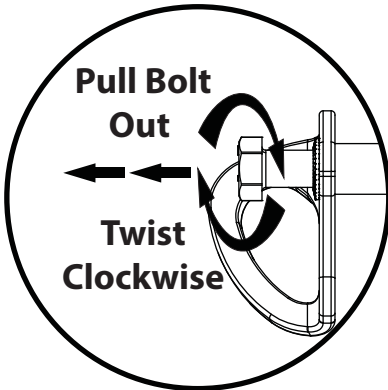

\*Proper placement should not allow movement of the hanger in any direction.

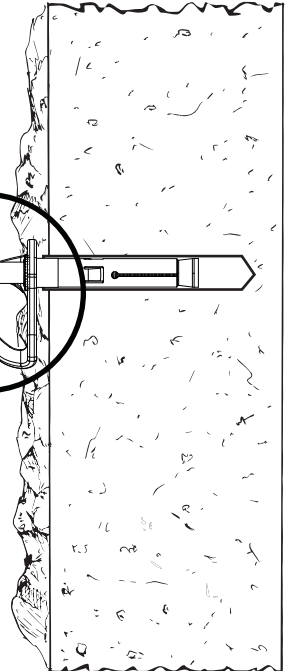

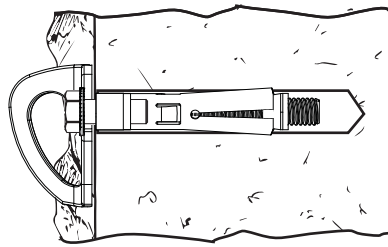

\*Installed anchor shown

## REMOVAL:

1. Use a 5/8" wrench or socket to loosen bolt until bolt head disengages from lock washer.

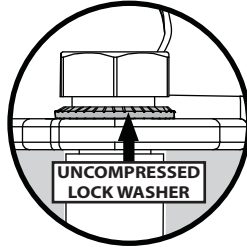
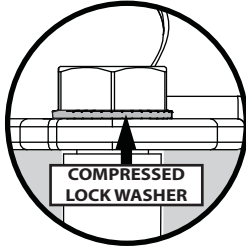

2. Continue to loosen the bolt until it hits the stop tabs at approximately 3/8" from the hanger. (The stop tabs provide a considerable increase in the torque required to continue removing the bolt, but it is possible for a determined user to over torque the bolt and break past the stop tabs) DO NOT LOOSEN PAST STOP TABS.

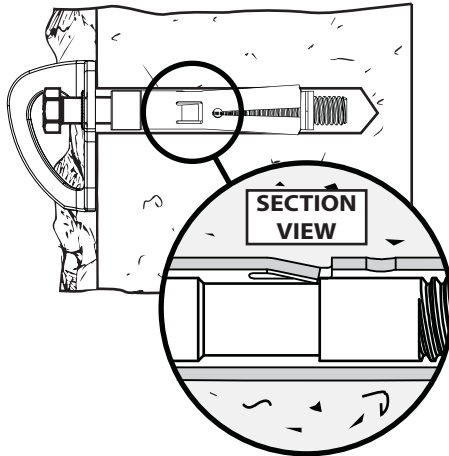

3. Tap bolt toward hanger until the bolt head contacts lockwasher.

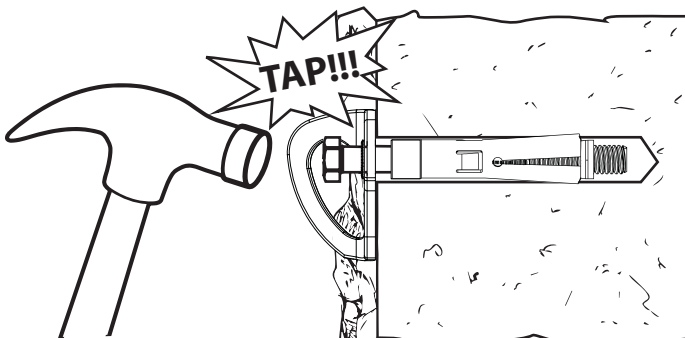

**\*3b** If bolt/cone are disengaged from the sleeve, move to step 4. Otherwise, repeat step 2 and 3 until bolt/cone disengage from sleeve. (see example above)

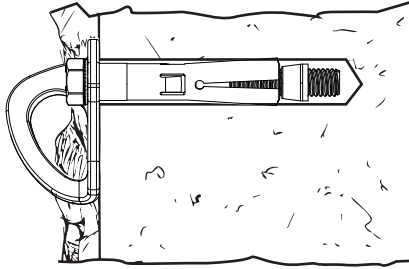

**4.** Pull up on bolt and unscrew (counter clockwise) until gap between bolt and hanger no longer increases (typically 2-3 full rotations).

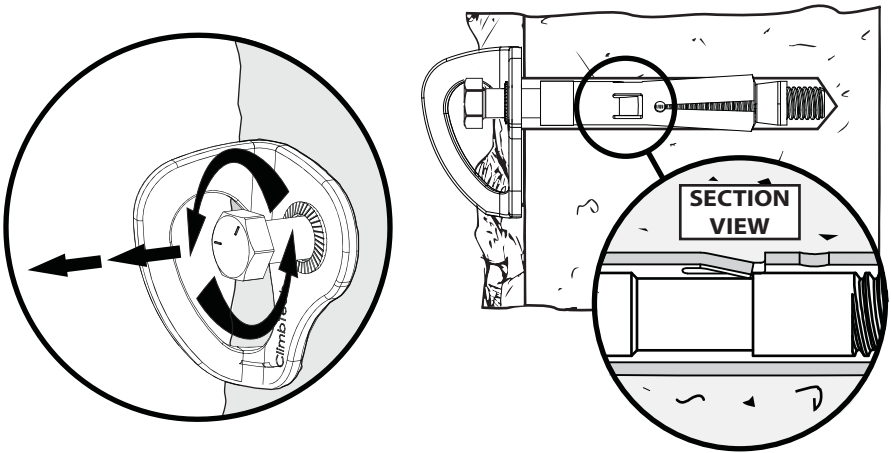

**5.** Pull hanger away from rock face. The entire assembly should come out as one unit. This step may require some prying depending on placement and conditions (sleeve flaring in soft rock, mineral deposition, etc.)

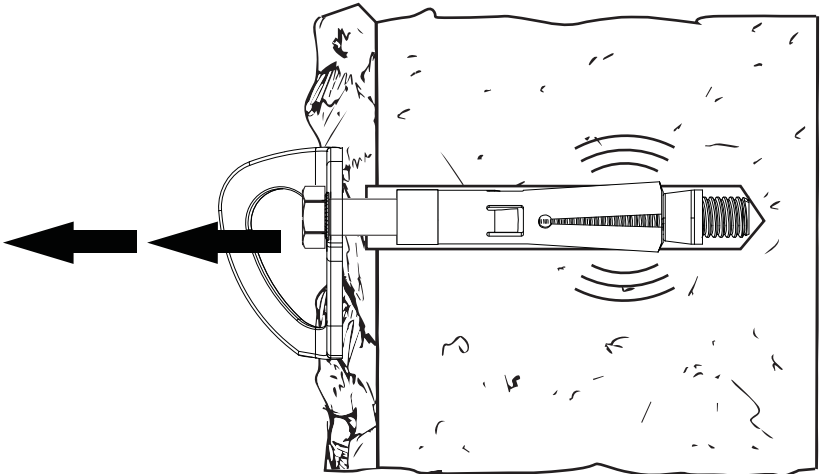

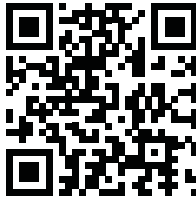

[www.climbtechgear.com](http://www.climbtechgear.com)

## **Product Warranty, Limited Remedy and Limitation of Liability**

**WARRANTY: THE FOLLOWING IS MADE IN LIEU OF ALL WARRANTIES OR CONDITIONS, EXPRESS OR IMPLIED, INCLUDING THE IMPLIED WARRANTIES OR CONDITIONS OF MERCHANTABILITY OR FITNESS FOR A PARTICULAR PURPOSE.** Equipment offered by ClimbTech is warranted against factory defects in workmanship and materials for a period of one year from date of purchase.

**LIMITED REMEDY:** Upon notice in writing, ClimbTech will repair or replace all defective items at ClimbTech's sole discretion. ClimbTech reserves the right to require that the defective item be returned to its plant for inspection before determining the appropriate course action. Warranty does not cover equipment damage resulting from wear, abuse, damage in transit, failure to maintain the product or other damage beyond the control of ClimbTech. ClimbTech shall be the sole judge of product condition and warranty options. This warranty applies only to original purchaser and is the only warranty applicable to this product. Please contact ClimbTech technical service department for assistance.

**LIMITATION OF LIABILITY: IN NO EVENT WILL CLIMBTECH BE LIABLE FOR ANY INDIRECT, INCIDENTAL, SPECIAL OR CONSEQUENTIAL DAMAGES INCLUDING, BUT NOT LIMITED TO LOSS OF PROFITS, IN ANY WAY RELATED TO THE PRODUCTS REGARDLESS OF THE LEGAL THEORY ASSERTED.**



**ClimbTech**

**ClimbTech, LLC.  
7303 Burleson Rd.  
Suite 901  
Austin, TX 78744  
1(512)308-6440  
[www.climbtechgear.com](http://www.climbtechgear.com)**